

# Mensch-Maschine-Interaktion



# Kapitel 4 - Motorik

- Fitts' Law
- Steering Law
- Interaktion mit beiden Händen

# Genauigkeit vs. Geschwindigkeit



SPEED ACCURACY  
TRADEOFF

# Fitts' Experiment

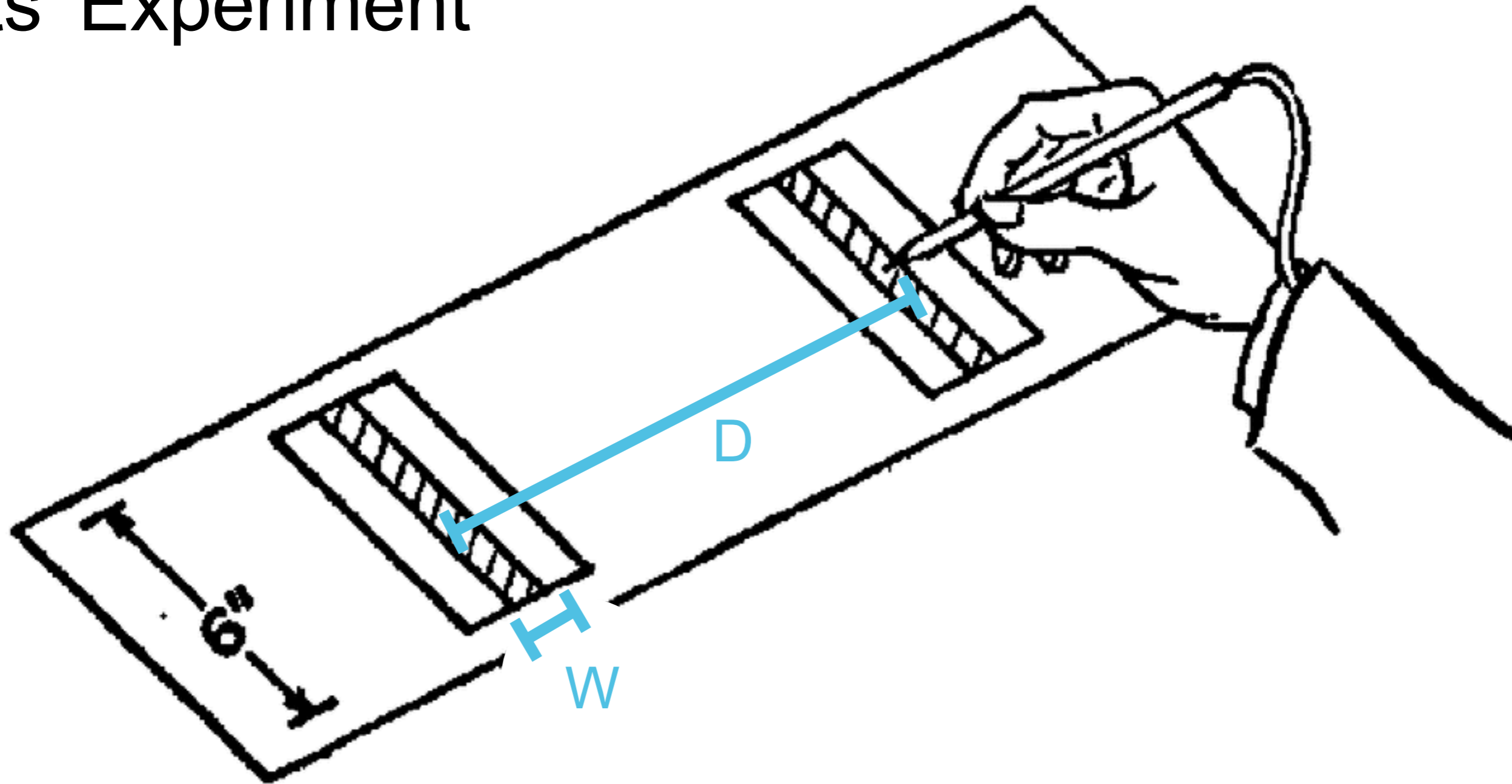

$$MT = a + b * ID = a + b * \log_2\left(\frac{D}{W} + 1\right)$$

# Ziele vergrößern, aber richtig!

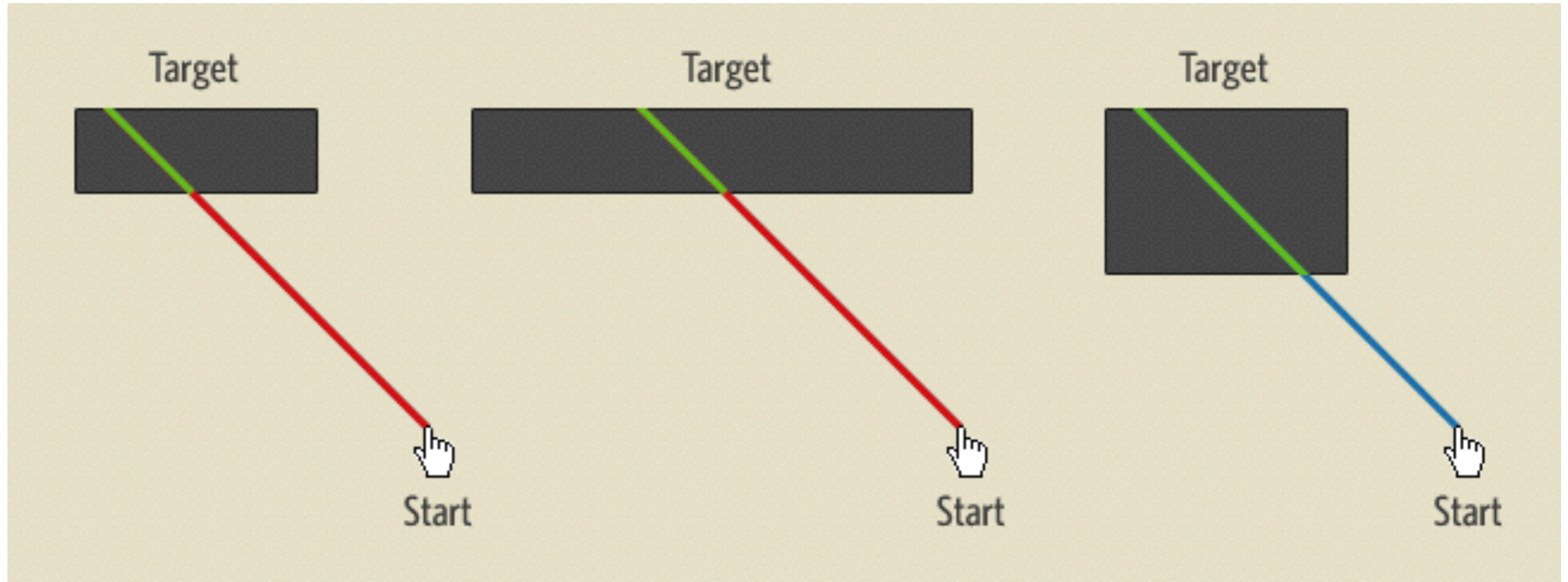

<http://www.particletree.com/features/visualizing-fittss-law/>

# Nicht alle Pixel sind gleich (vor Fitts' Gesetz)

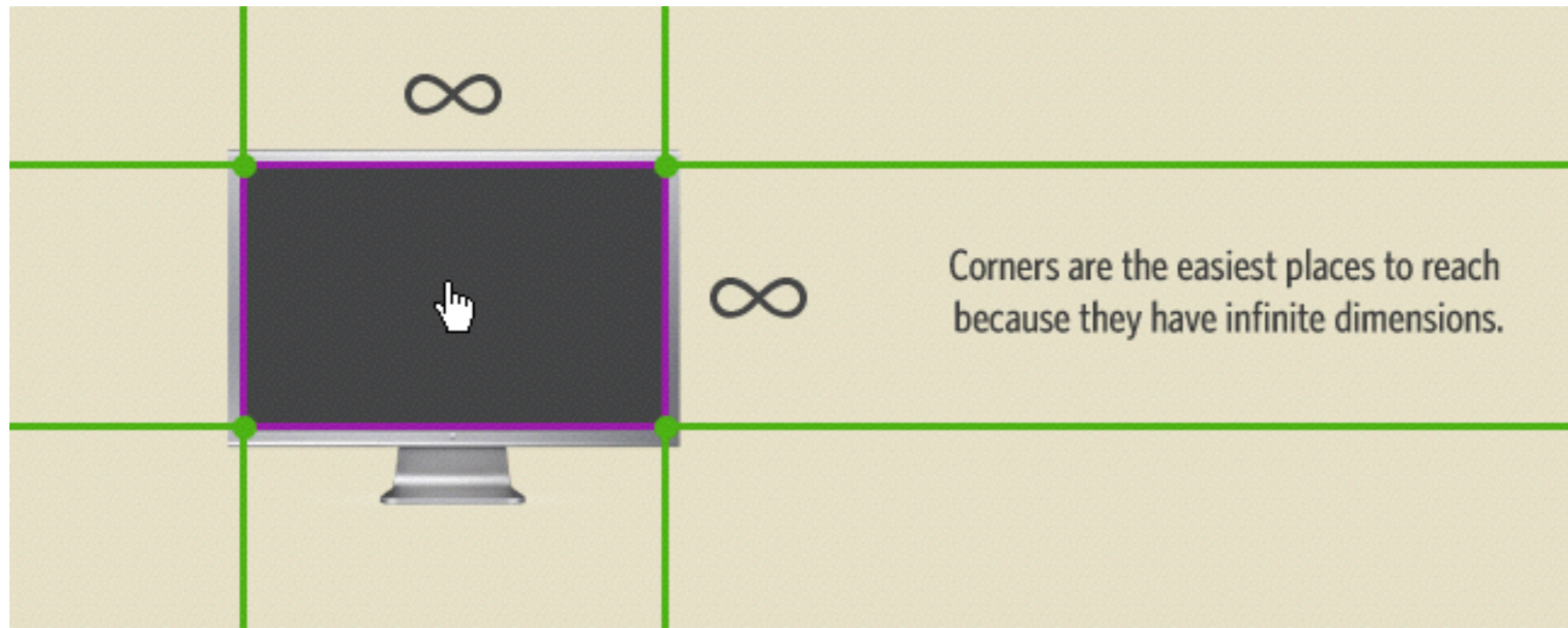
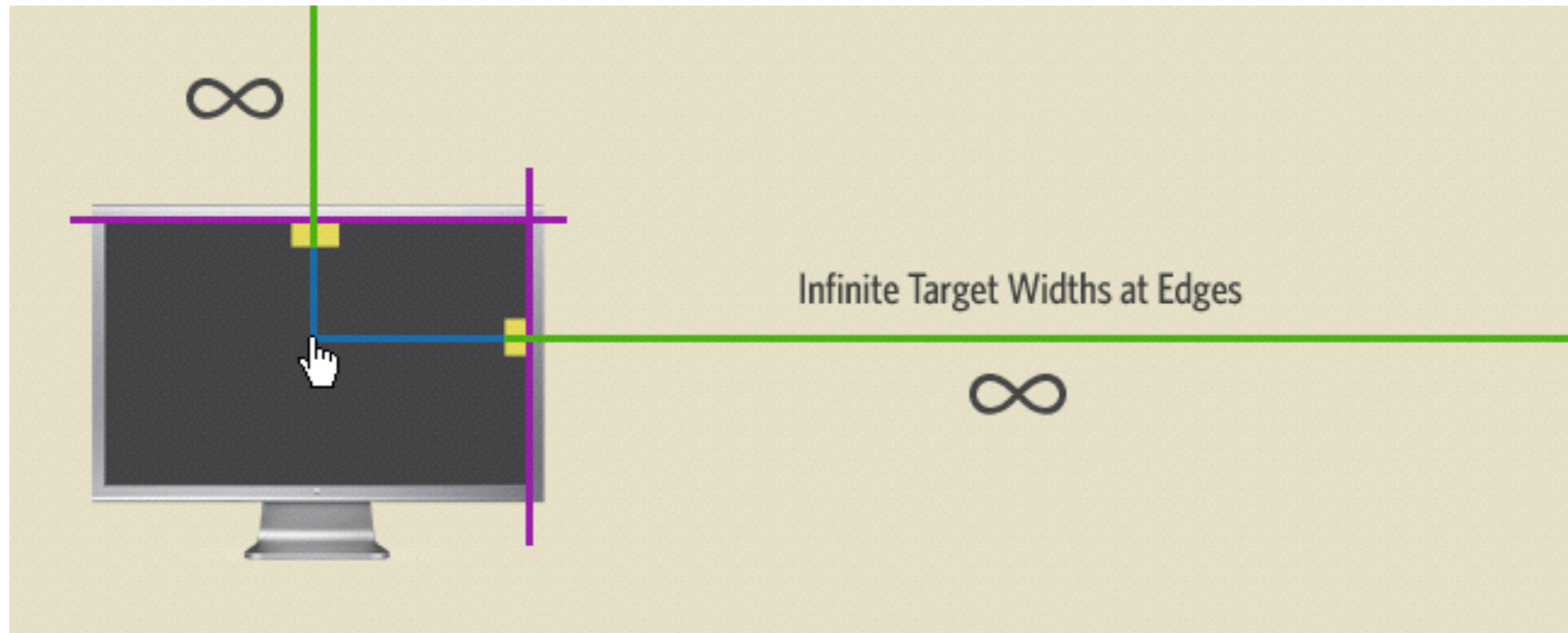

# Diskussion: Pie Menüs

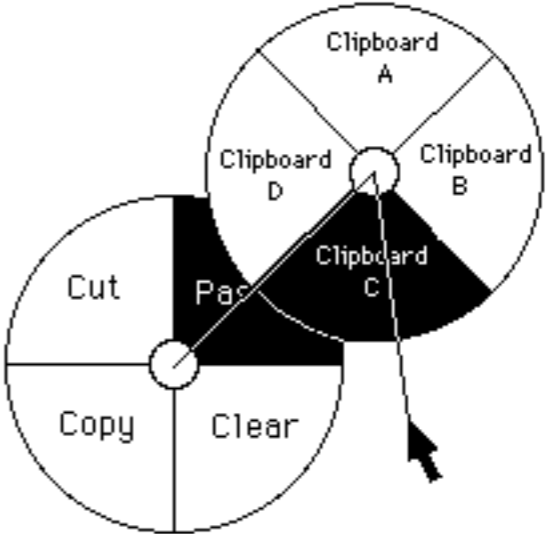
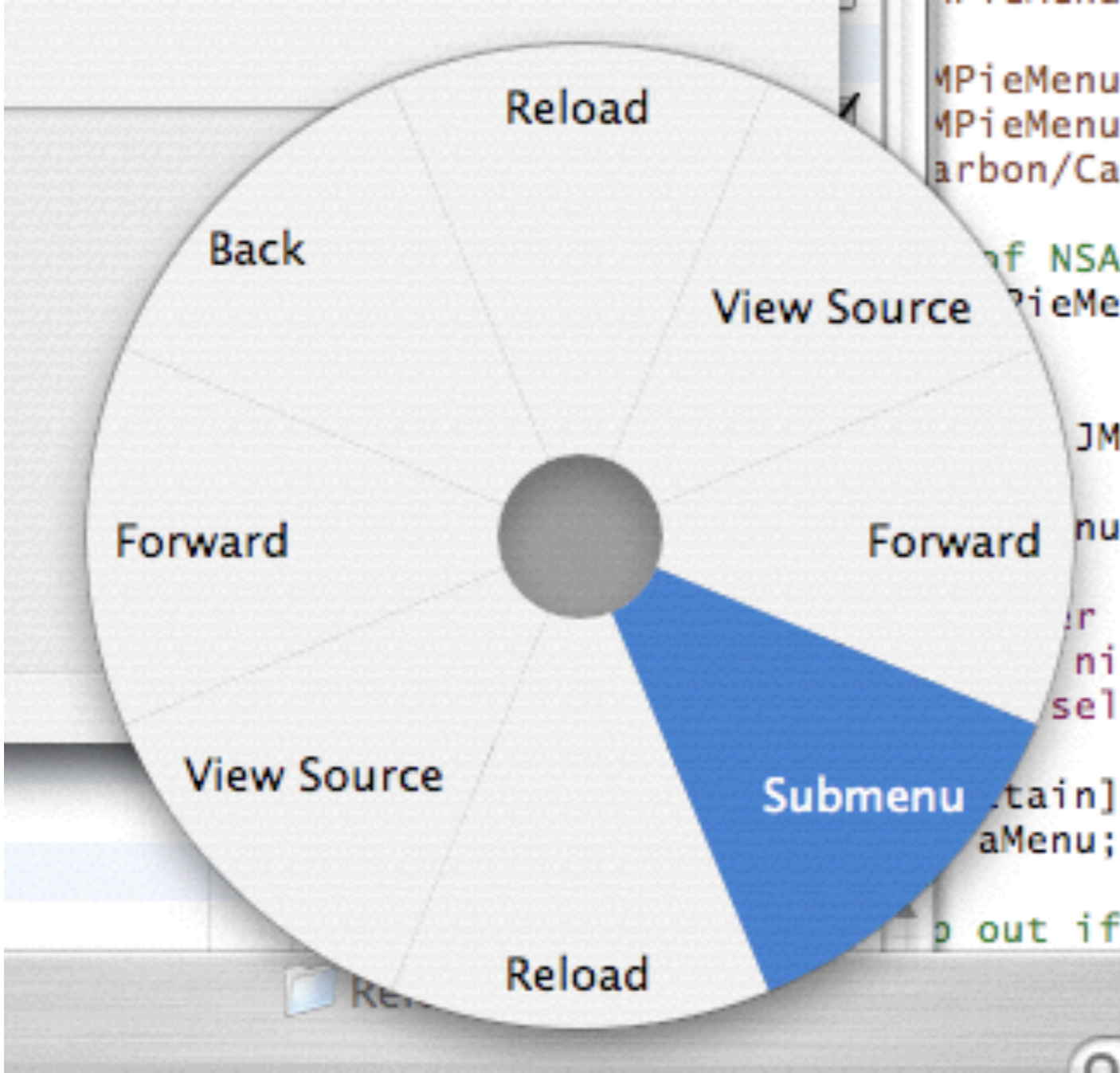

# Kapitel 4 - Motorik

- Fitts' Law
- Steering Law
- Interaktion mit beiden Händen



# Steuergesetz???

<http://www.all-wallpapers.net/wp-content/uploads/2012/12/Winding-Road-Nature.jpeg>



# Zeit zum Befahren einer engen Straße

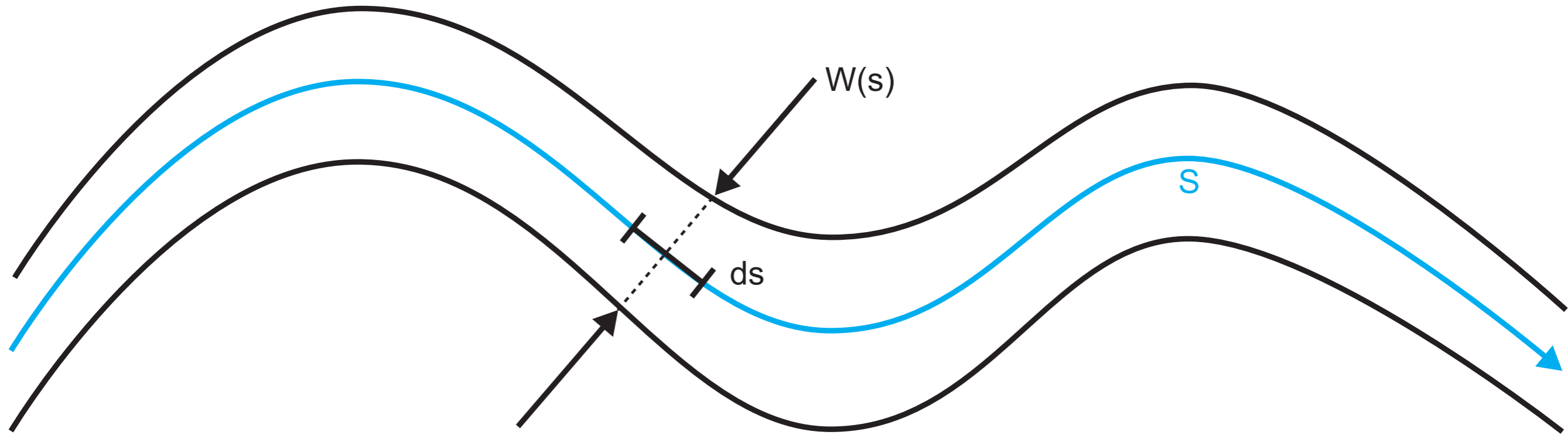

$$T = a + b * \int_S \frac{1}{W(s)} ds$$

# Enge Straßen am Bildschirm

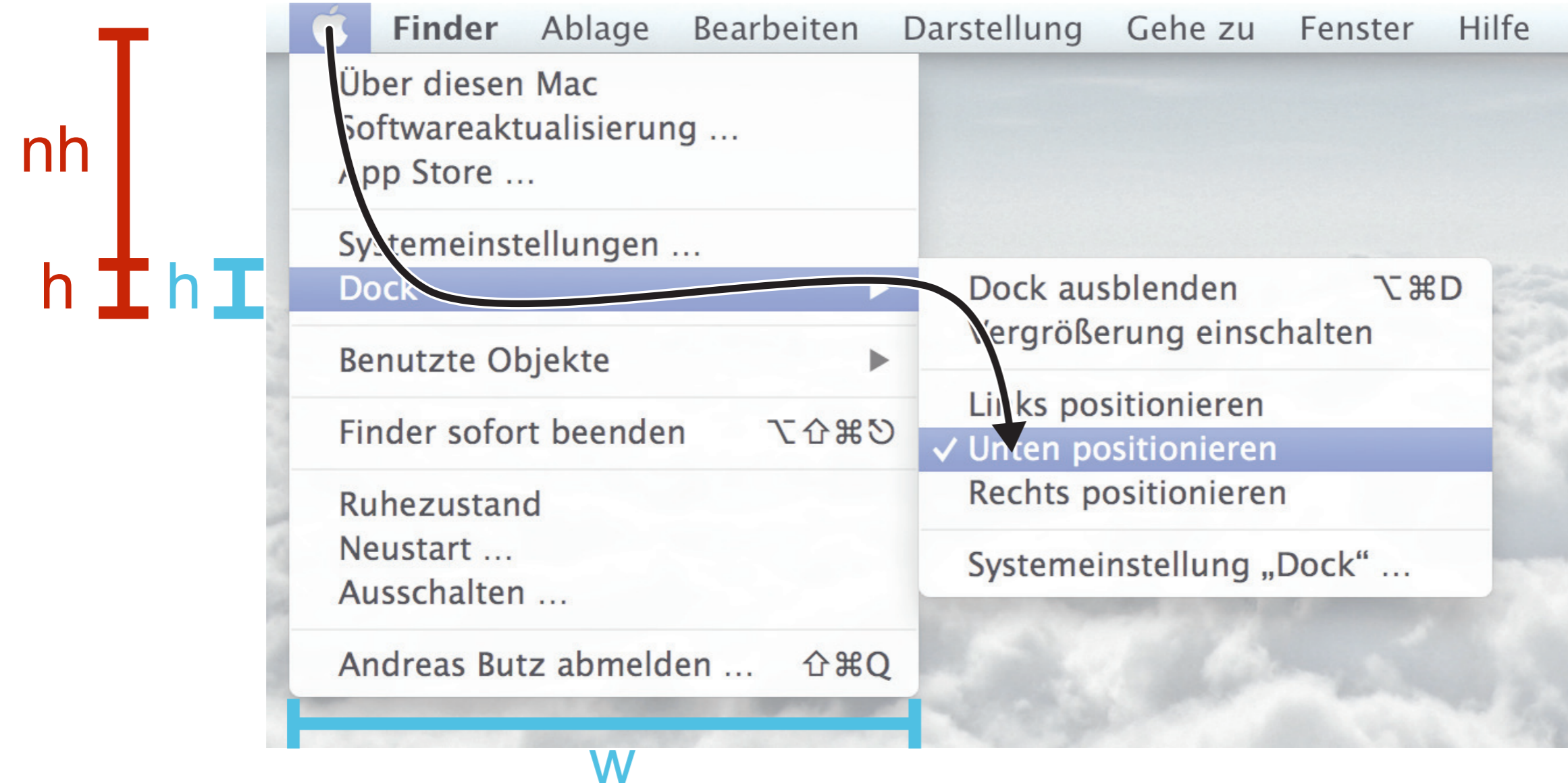

$$T = a_1 + b_1 * \log_2\left(\frac{nh}{h} + 1\right) + a_2 + b_2 * \frac{w}{h} + \dots$$

vertikal: Fitts' law

horizontal: steering law

# Kurz Nachdenken: Computerspiele

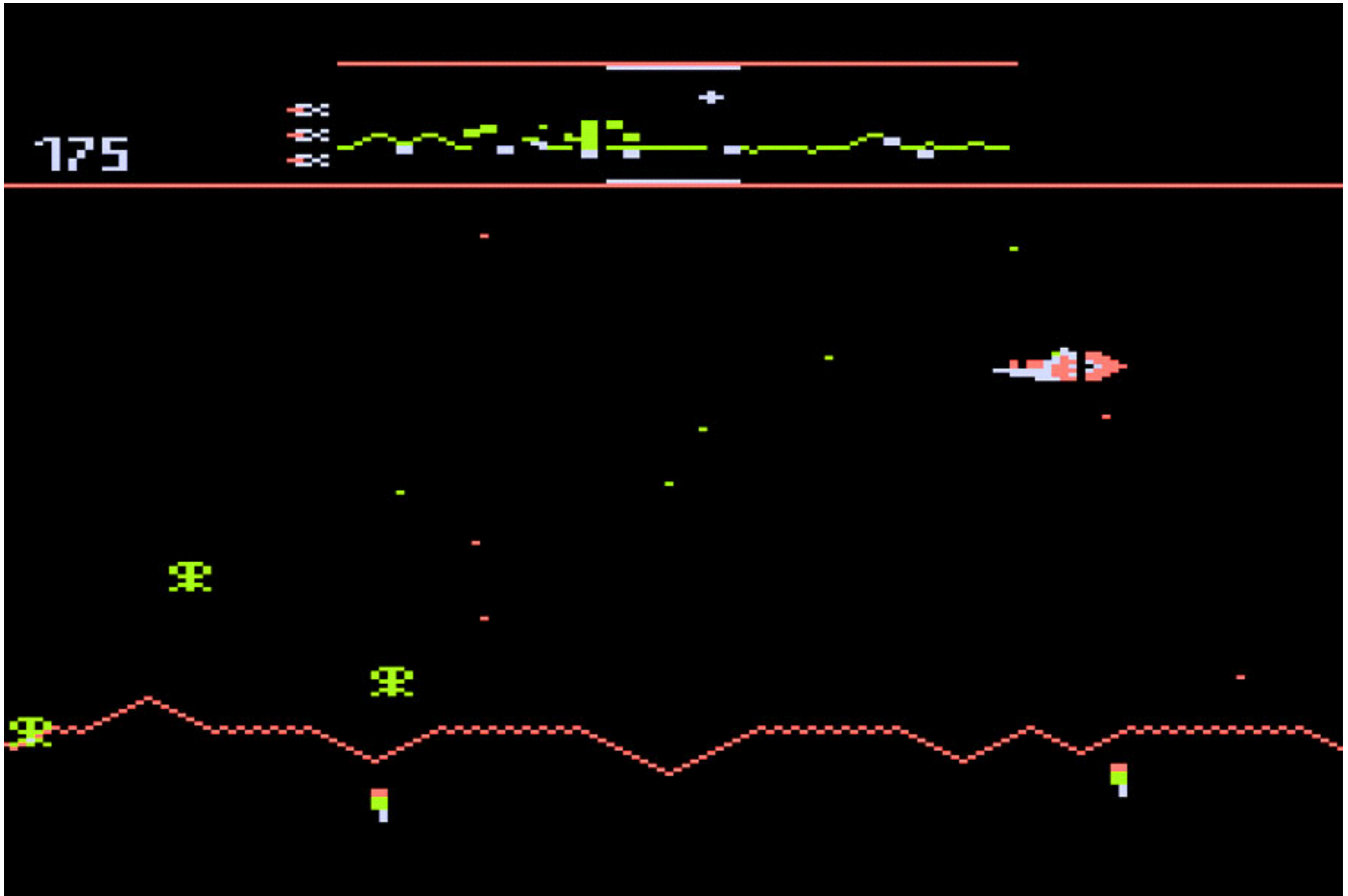

# Kapitel 4 - Motorik

- Fitts' Law
- Steering Law
- Interaktion mit beiden Händen



# Yves Guiard's Experiment

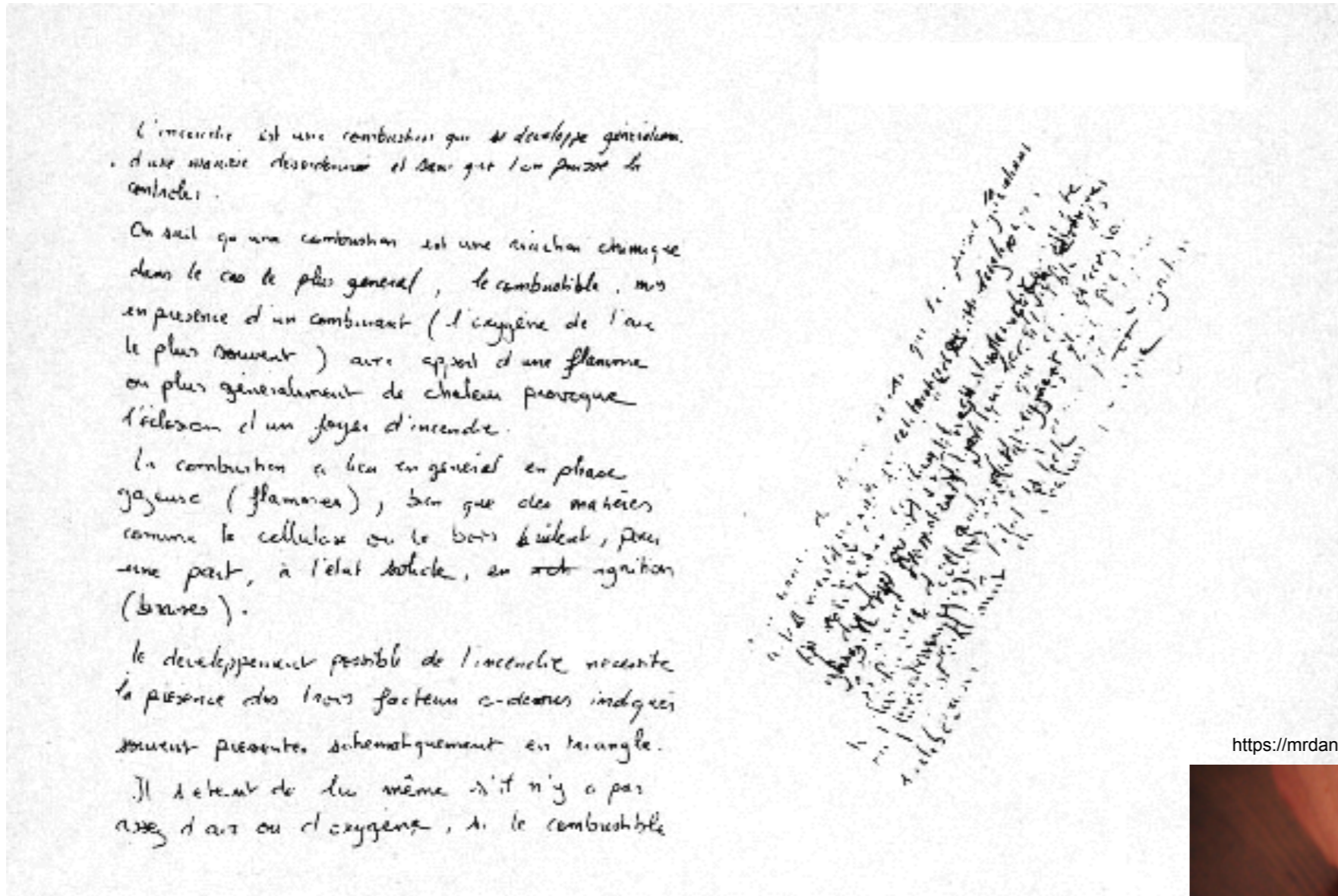

[http://cogprints.org/625/1/jmb\\_87.html](http://cogprints.org/625/1/jmb_87.html)

[https://mrdanbaird.files.wordpress.com/2014/01/wp-id-3293117576\\_05f43d8305\\_b.jpg?w=1024](https://mrdanbaird.files.wordpress.com/2014/01/wp-id-3293117576_05f43d8305_b.jpg?w=1024)



# Beispiel: Golfspieler

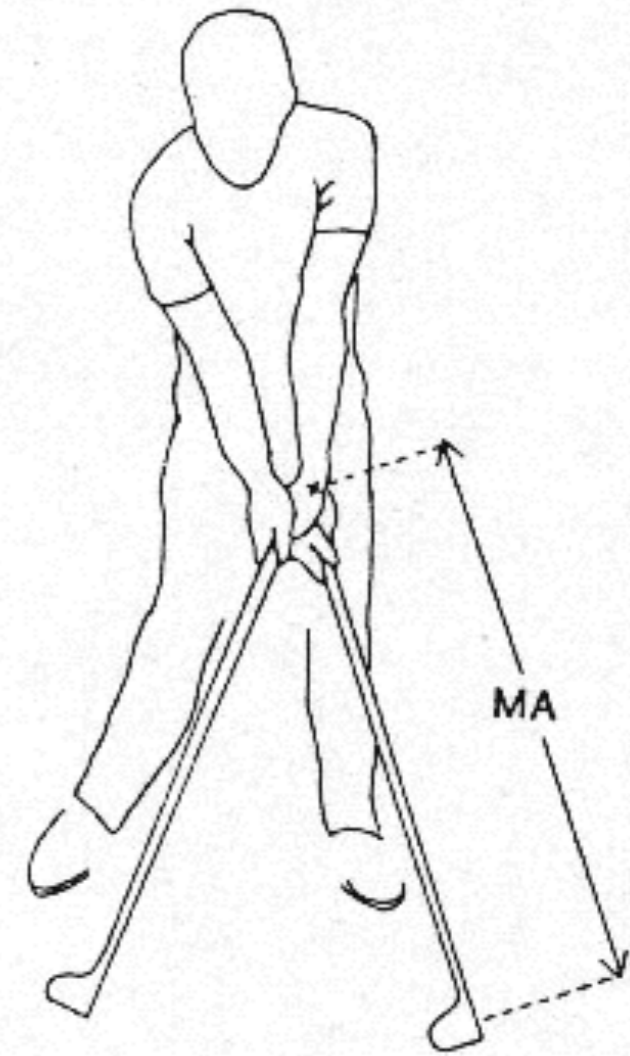
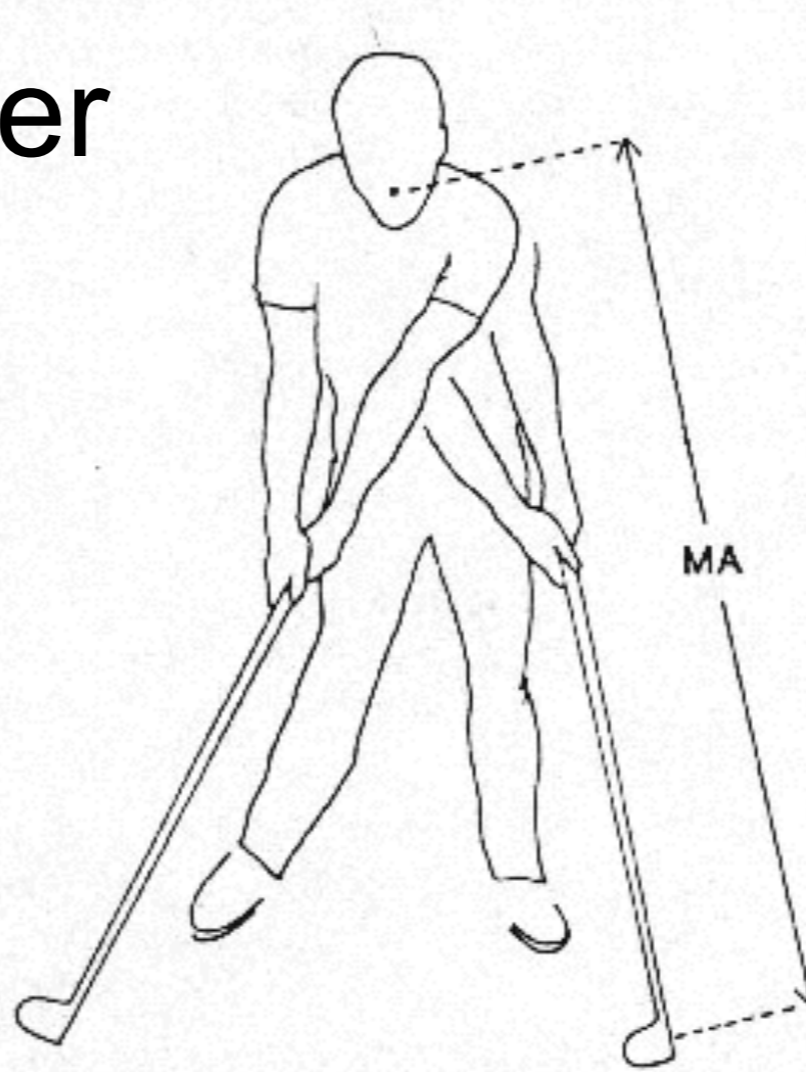

[http://cogprints.org/625/1/jmb\\_87.html](http://cogprints.org/625/1/jmb_87.html)

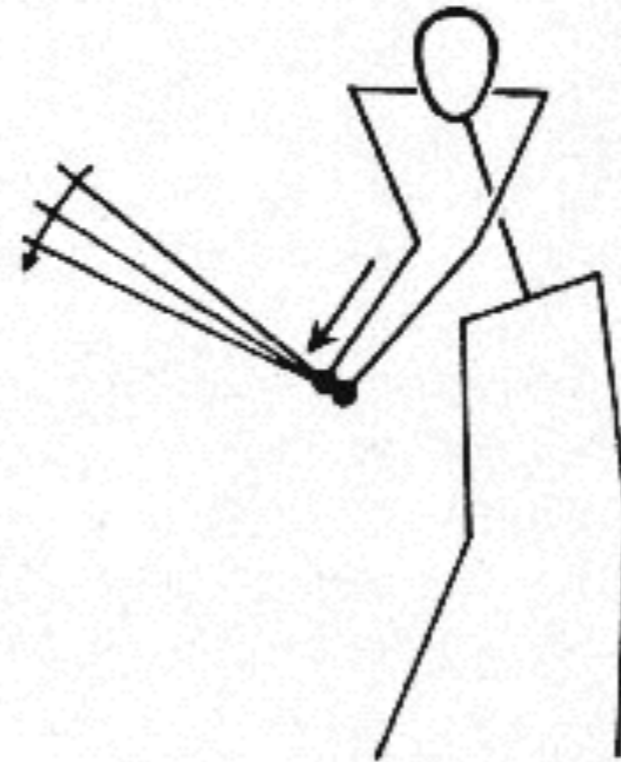
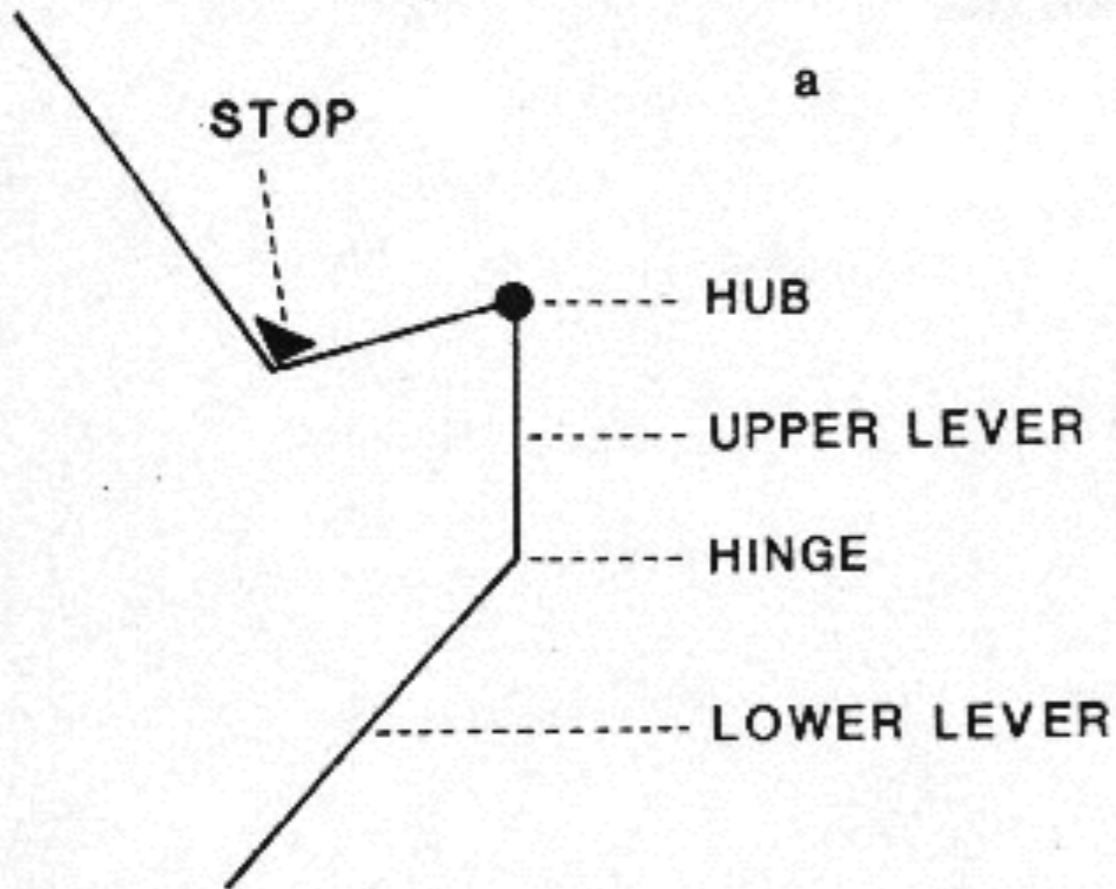



# Die motorische Kette

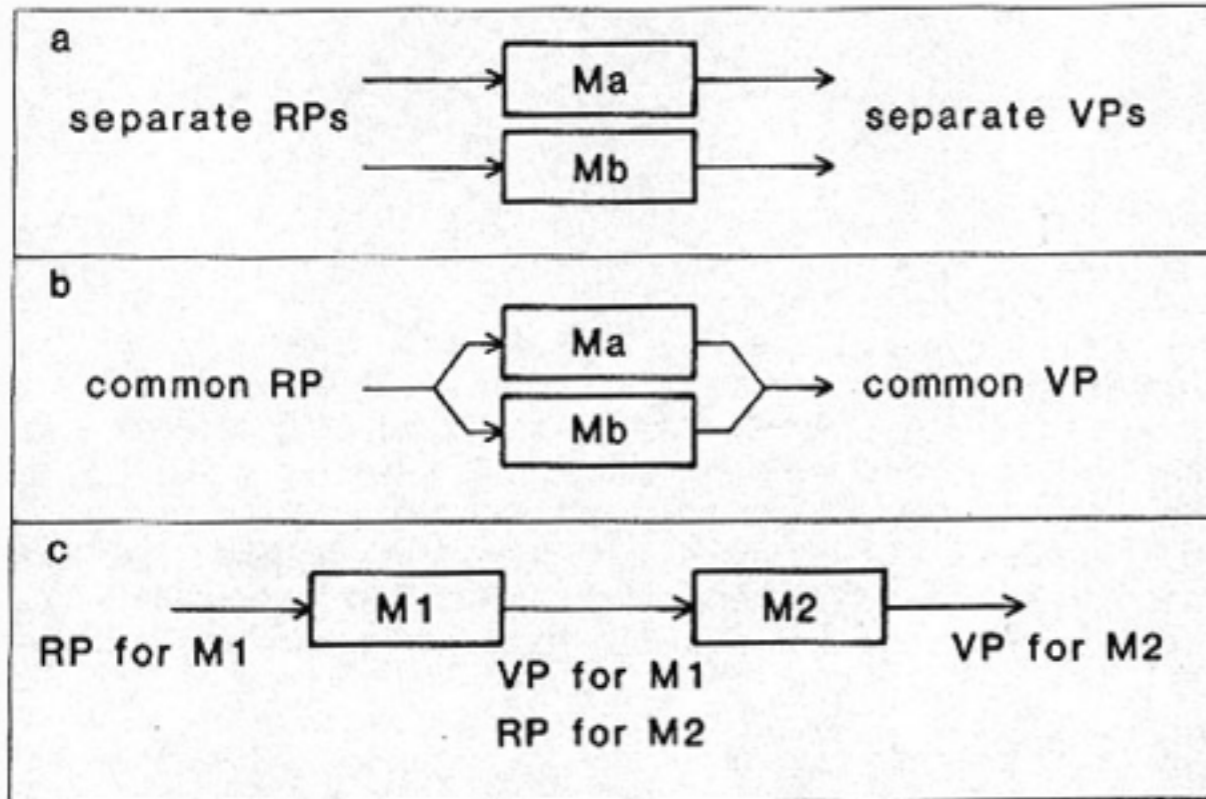
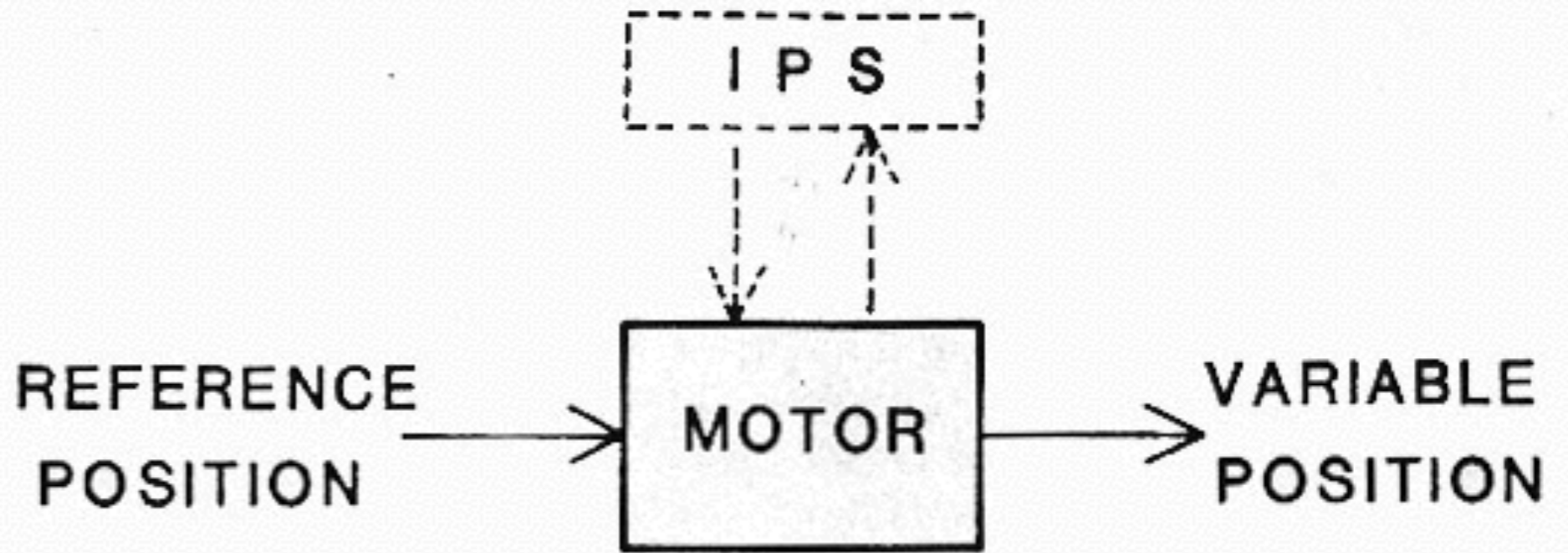

[http://cogprints.org/625/1/jmb\\_87.html](http://cogprints.org/625/1/jmb_87.html)

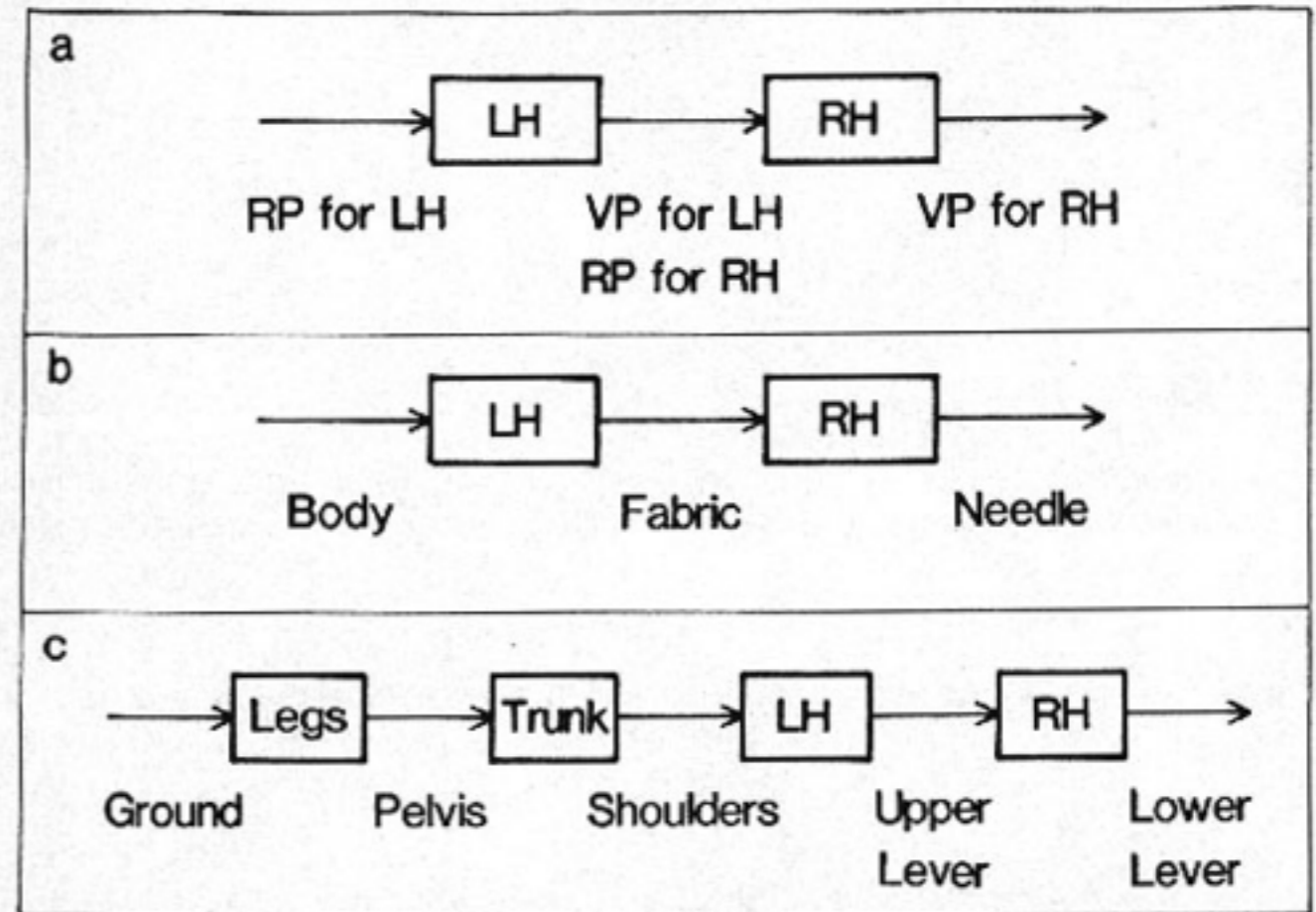

# Photohelix: Beispiel für die Verwendung



# Mini-Brainstorming

- Welche Handlungen im Alltag haben bzgl. der Hände eine
  - symmetrische Verteilung?
  - asymmetrische Verteilung?



<http://www.kanadaspezialist.com/2011/01/06/kanada-essen-alle-kanadier-ohne-gabeln-und-mit-den-ellenbogen-auf-dem-tisch/3633/>



<http://www.wdr5.de/sendungen/morgenecho/serien/serienueberblick/delikat100.html>